

5.8A, 200V, 0.600 Ohm, N-Channel Power MOSFET

This is an N-Channel enhancement mode silicon gate power field effect transistor designed for applications such as switching regulators, switching converters, motor drivers, relay drivers, and drivers for high power bipolar switching transistors requiring high speed and low gate drive power. This type can be operated directly from integrated circuits.

Formerly developmental type TA4600.

Ordering Information

| PART NUMBER | PACKAGE | BRAND |
|-------------|----------|--------|
| BUZ73A | TO-220AB | BUZ73A |

NOTE: When ordering, use the entire part number.

Features

- 5.8A, 200V
- $r_{DS(ON)} = 0.600\Omega$
- SOA is Power Dissipation Limited
- Nanosecond Switching Speeds
- Linear Transfer Characteristics
- High Input Impedance
- Majority Carrier Device
- Related Literature
 - TB334 "Guidelines for Soldering Surface Mount Components to PC Boards"

Symbol

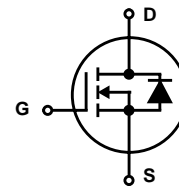

Packaging

JEDEC TO-220AB

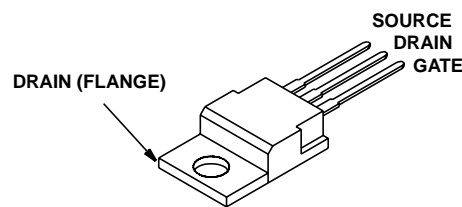

BUZ73A

Absolute Maximum Ratings $T_C = 25^\circ\text{C}$, Unless Otherwise Specified

| | BUZ76A | UNITS |
|--|------------|---------------------------|
| Drain to Source Breakdown Voltage (Note 1) | 200 | V |
| Drain to Gate Voltage ($R_{GS} = 20\text{k}\Omega$) (Note 1) | 200 | V |
| Continuous Drain Current ($T_C = 30^\circ\text{C}$) | 5.8 | A |
| Pulsed Drain Current (Note 3) | 23 | A |
| Gate to Source Voltage | ± 20 | V |
| Maximum Power Dissipation | 40 | W |
| Linear Derating Factor | 0.32 | $\text{W}/^\circ\text{C}$ |
| Operating and Storage Temperature | -55 to 150 | $^\circ\text{C}$ |
| DIN Humidity Category - DIN 40040 | E | |
| IEC Climatic Category - DIN IEC 68-1 | 55/150/56 | |
| Maximum Temperature for Soldering | | |
| Leads at 0.063in (1.6mm) from Case for 10s | 300 | $^\circ\text{C}$ |
| Package Body for 10s, See Techbrief 334 | 260 | $^\circ\text{C}$ |

CAUTION: Stresses above those listed in "Absolute Maximum Ratings" may cause permanent damage to the device. This is a stress only rating and operation of the device at these or any other conditions above those indicated in the operational sections of this specification is not implied.

NOTE:

1. $T_J = 25^\circ\text{C}$ to 125°C .

Electrical Specifications $T_C = 25^\circ\text{C}$, Unless Otherwise Specified

| PARAMETER | SYMBOL | TEST CONDITIONS | MIN | TYP | MAX | UNITS |
|--|-----------------|--|------------|-----|-------|---------------------------|
| Drain to Source Breakdown Voltage | BV_{DSS} | $I_D = 250\mu\text{A}$, $V_{GS} = 0\text{V}$ | 200 | - | - | V |
| Gate to Threshold Voltage | $V_{GS(TH)}$ | $V_{GS} = V_{DS}$, $I_D = 1\text{mA}$ (Figure 9) | 2.1 | 3 | 4 | V |
| Zero Gate Voltage Drain Current | I_{DSS} | $T_J = 25^\circ\text{C}$, $V_{DS} = 200\text{V}$, $V_{GS} = 0\text{V}$ | - | 20 | 250 | μA |
| | | $T_J = 125^\circ\text{C}$, $V_{DS} = 200\text{V}$, $V_{GS} = 0\text{V}$ | - | 100 | 1000 | μA |
| Gate to Source Leakage Current | I_{GSS} | $V_{GS} = 20\text{V}$, $V_{DS} = 0\text{V}$ | - | 10 | 100 | nA |
| Drain to Source On Resistance (Note 2) | $r_{DS(ON)}$ | $I_D = 3.5\text{A}$, $V_{GS} = 10\text{V}$ (Figure 8) | - | 0.5 | 0.600 | Ω |
| Forward Transconductance (Note 2) | g_{fs} | $V_{DS} = 25\text{V}$, $I_D = 3.5\text{A}$ (Figure 11) | 2.2 | 3.5 | - | S |
| Turn-On Delay Time | $t_{d(ON)}$ | $V_{CC} = 30\text{V}$, $I_D \approx 2.8\text{A}$, $V_{GS} = 10\text{V}$, $R_{GS} = 50\Omega$, $R_L = 10\Omega$. (Figures 14, 15) | - | 15 | 20 | ns |
| Rise Time | t_r | | - | 40 | 60 | ns |
| Turn-Off Delay Time | $t_{d(OFF)}$ | | - | 70 | 90 | ns |
| Fall Time | t_f | | - | 40 | 55 | ns |
| Input Capacitance | C_{ISS} | $V_{DS} = 25\text{V}$, $V_{GS} = 0\text{V}$, $f = 1\text{MHz}$ (Figure 10) | - | 450 | 600 | pF |
| Output Capacitance | C_{OSS} | | - | 100 | 160 | pF |
| Reverse Transfer Capacitance | C_{RSS} | | - | 50 | 80 | pF |
| Thermal Resistance Junction to Case | $R_{\theta JC}$ | | ≤ 3.1 | | | $^\circ\text{C}/\text{W}$ |
| Thermal Resistance Junction to Ambient | $R_{\theta JA}$ | | ≤ 75 | | | $^\circ\text{C}/\text{W}$ |

Source to Drain Diode Specifications

| PARAMETER | SYMBOL | TEST CONDITIONS | MIN | TYP | MAX | UNITS |
|------------------------------------|-----------|---|-----|-----|-----|---------------|
| Continuous Source to Drain Current | I_{SD} | $T_C = 25^\circ\text{C}$ | - | - | 5.8 | A |
| Pulsed Source to Drain Current | I_{SDM} | | - | - | 23 | A |
| Drain to Source Diode Voltage | V_{SD} | $T_J = 25^\circ\text{C}$, $I_{SD} = 11.6\text{A}$, $V_{GS} = 0\text{V}$ | - | 1.4 | 1.7 | V |
| Reverse Recovery Time | t_{rr} | $T_J = 25^\circ\text{C}$, $I_{SD} = 5.8\text{A}$, $dI_{SD}/dt = 100\text{A}/\mu\text{s}$, $V_R = 100\text{V}$ | - | 200 | - | ns |
| Reverse Recovery Charge | Q_{RR} | | - | 0.6 | - | μC |

NOTES:

2. Pulse Test: Pulse width $\leq 300\mu\text{s}$, duty cycle $\leq 2\%$.
3. Repetitive rating: pulse width limited by maximum junction temperature. See Transient Thermal Impedance curve (Figure 3).

Typical Performance Curves Unless Otherwise Specified

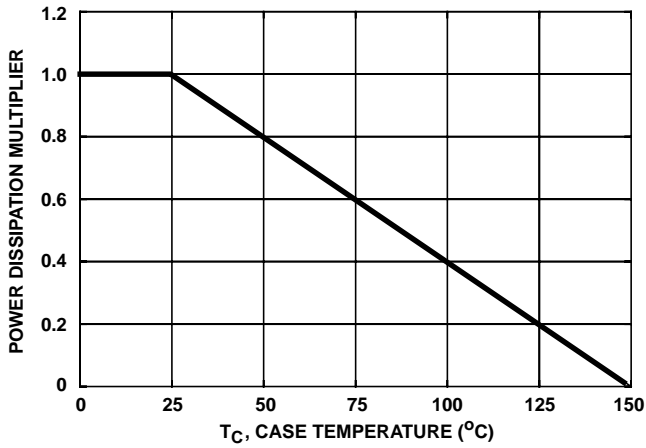

FIGURE 18. NORMALIZED POWER DISSIPATION vs CASE TEMPERATURE

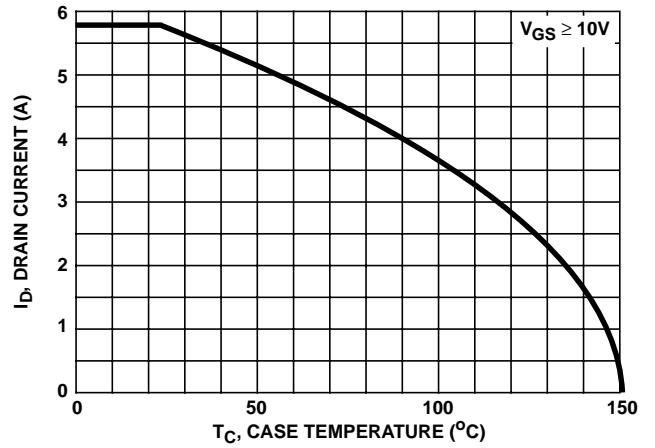

FIGURE 19. MAXIMUM CONTINUOUS DRAIN CURRENT vs CASE TEMPERATURE

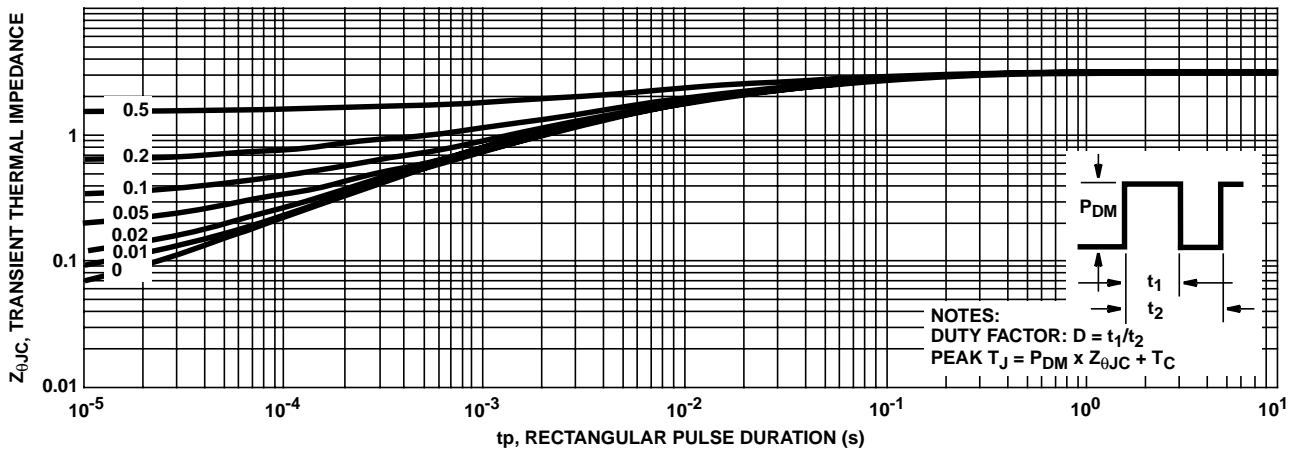

FIGURE 20. MAXIMUM TRANSIENT THERMAL IMPEDANCE

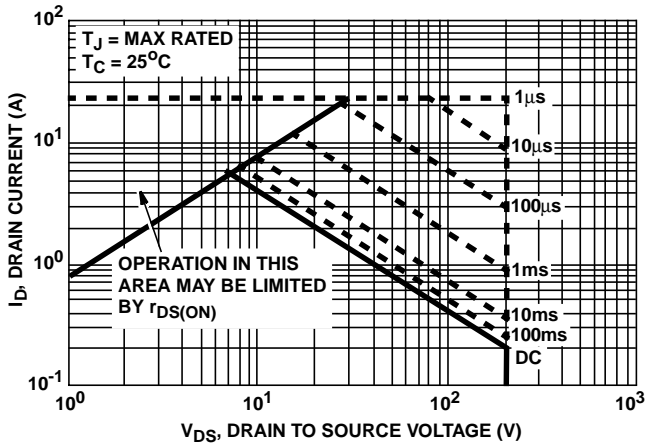

FIGURE 21. FORWARD BIAS SAFE OPERATING AREA

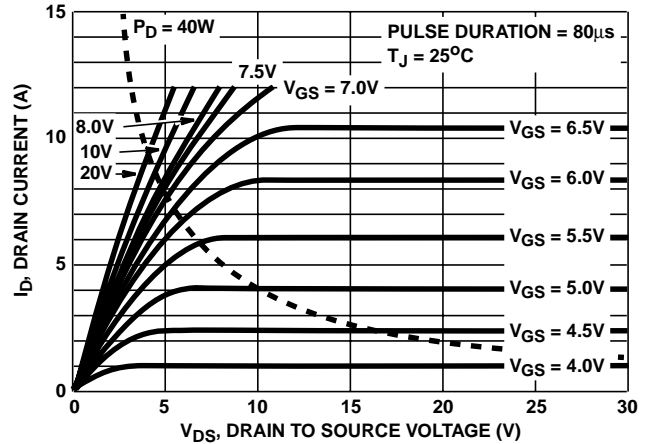

FIGURE 22. OUTPUT CHARACTERISTICS

Typical Performance Curves Unless Otherwise Specified (Continued)

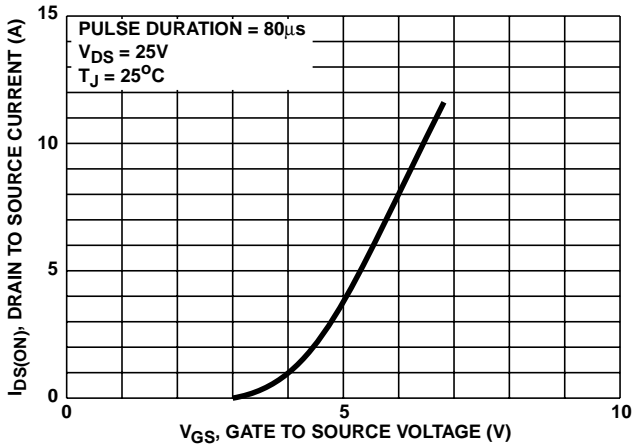

FIGURE 23. TRANSFER CHARACTERISTICS

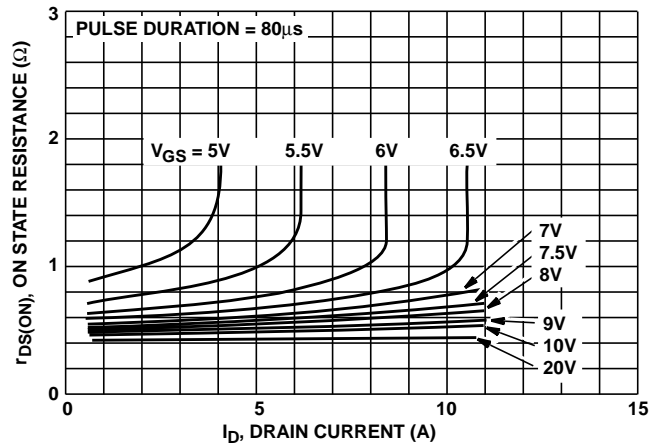

FIGURE 24. DRAIN TO SOURCE ON RESISTANCE vs GATE VOLTAGE AND DRAIN CURRENT

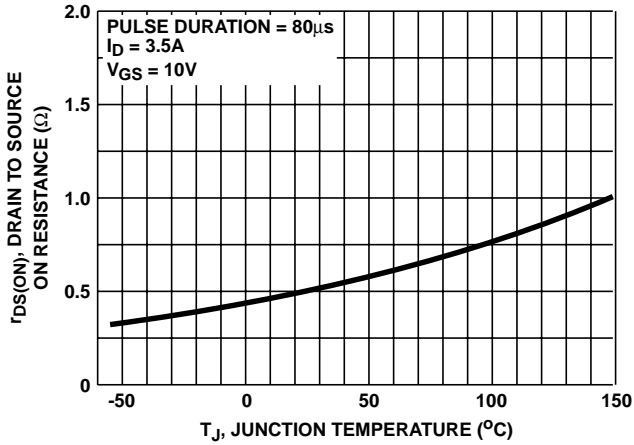

FIGURE 25. DRAIN TO SOURCE ON RESISTANCE vs JUNCTION TEMPERATURE

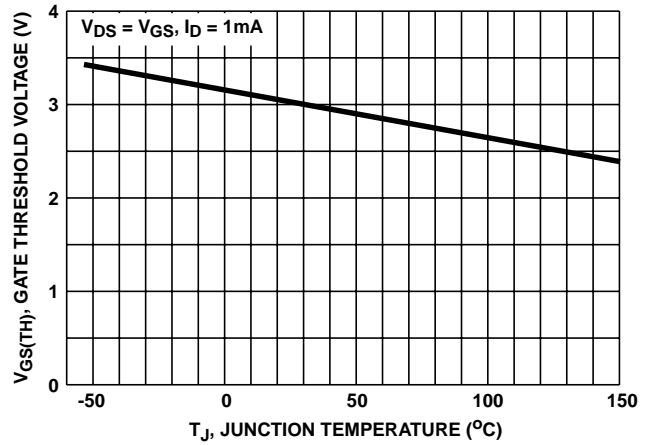

FIGURE 26. GATE THRESHOLD VOLTAGE vs JUNCTION TEMPERATURE

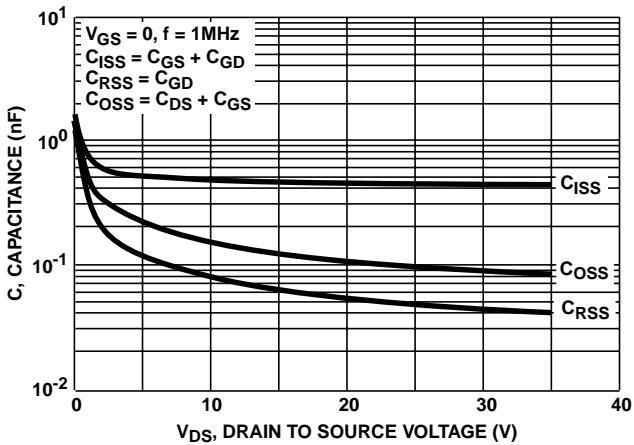

FIGURE 27. CAPACITANCE vs DRAIN TO SOURCE VOLTAGE

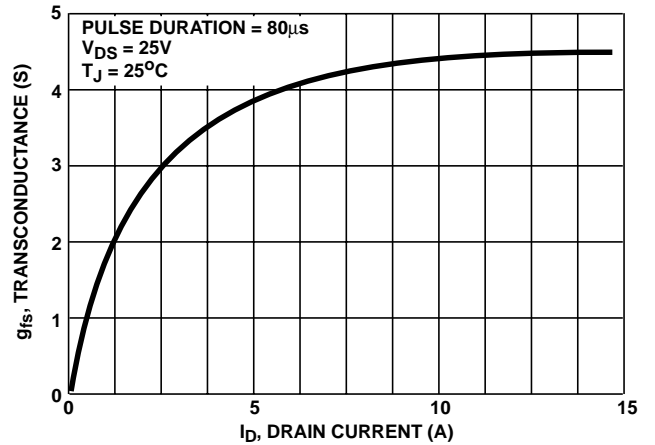

FIGURE 28. TRANSCONDUCTANCE vs DRAIN CURRENT

Typical Performance Curves Unless Otherwise Specified (Continued)

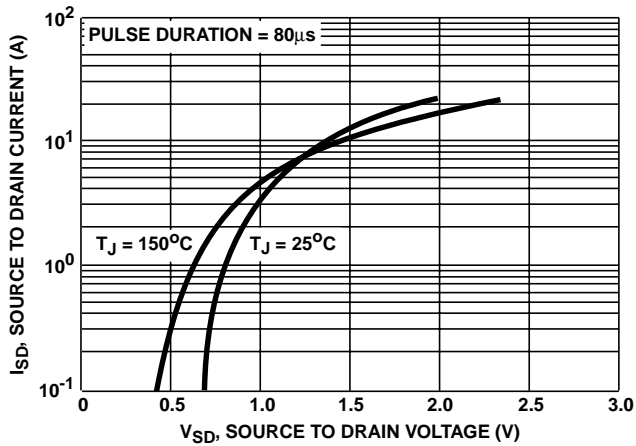

FIGURE 29. SOURCE TO DRAIN DIODE VOLTAGE

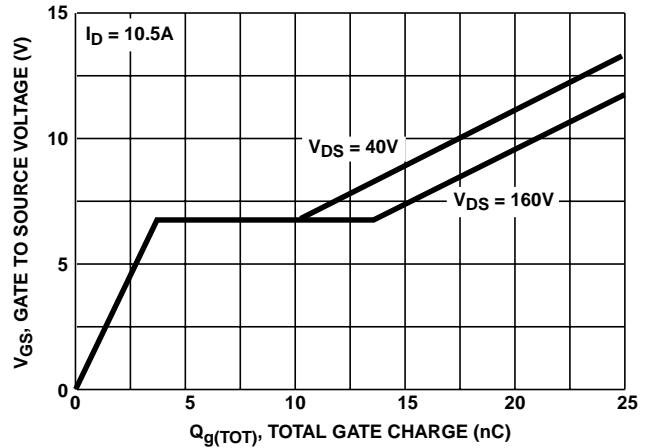

FIGURE 30. GATE TO SOURCE VOLTAGE vs GATE CHARGE

Test Circuits and Waveforms

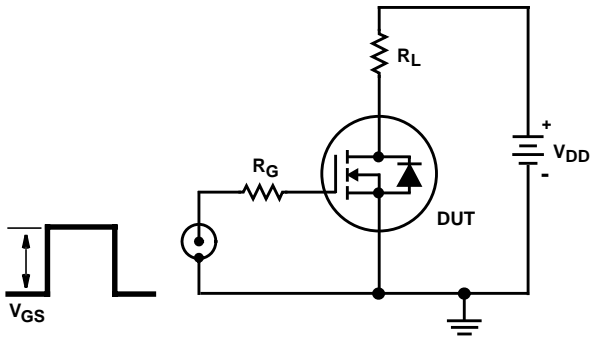

FIGURE 31. SWITCHING TIME TEST CIRCUIT

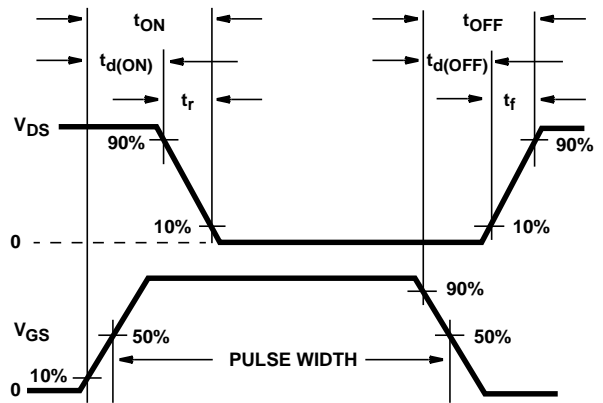

FIGURE 32. RESISTIVE SWITCHING WAVEFORMS

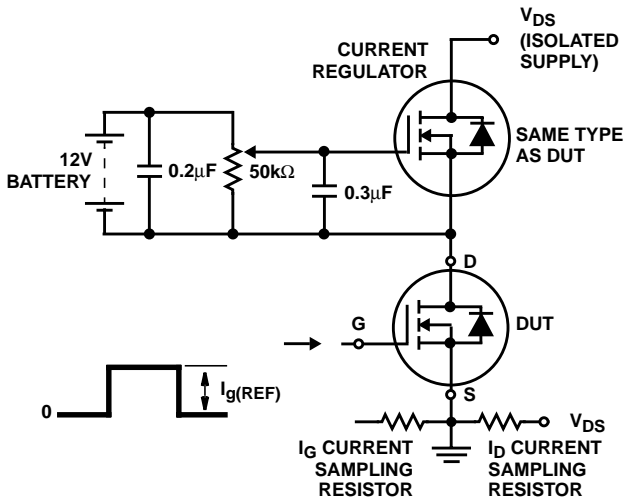

FIGURE 33. GATE CHARGE TEST CIRCUIT

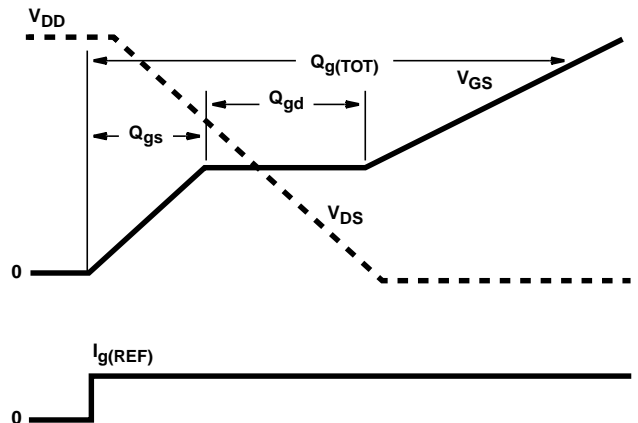

FIGURE 34. GATE CHARGE WAVEFORMS